

intraMic

The First Internal Microphone
For Woodwind Instruments

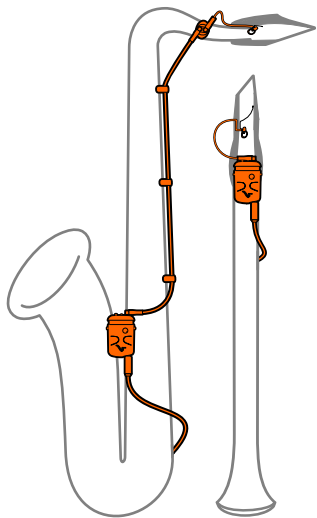

USER'S MANUAL

IC33 cells, S-Type / C-Type
13/04/2022
ENGLISH

 VIGAMUSICTOOLS®

Table of contents

1. Introduction	3
2. General overview of the intraMic	4
S-Type and C-Type IC31 cells	5
The preAmp	6
Accessories	7
3. Set up the intraMic on your instrument!	9
The various ways	9
Caution notes prior to installation and use of the cell	10
IC31 S-Type cell installation on saxophones	11
IC31 C-Type cell installation on clarinets	12
Inserting the removable belt clip on the PreAmp	13
Installing the intraMic preAmp and coupler	14
4. Fine tuning	17
Suggested settings for « brightness » and « presence » on the preAmp	17
PreAmp input gain setting	18
5. Storage and maintenance	20
Storing the intraMic cell	20
Routine maintenance	20
Exceptional maintenance	21
Changing the intraMic preAmp's battery	24
6. Technical Specifications	25
Technical specifications of the intraMic cell	25
Technical specifications of the intraMic preAmp	25
7. Warnings & limited liability disclaimer	26
8. Warranty	27

1. Introduction

First of all, thank you for purchasing our intraMic, world's first internal microphone for woodwind instrument, designed and handcrafted with passion in France.

You're now the proud owner of a patented device, resulting of extensive research based on edge-cutting technology, scientific knowledge and high-level artistic collaborations.

While started to come up with a way to add electronic sound effects to woodwind instruments, our project has evolved over time into a highly-versatile and high-end device designed for saxophonists and clarinetists of all levels to record themselves without issues posed by classic mics.

Our proposition: the intraMic. It delivers an analogic high-fidelity sound output, totally homogeneous accross all the instrument's range, without any surrounding noise or feedback at all!

Easy to set up, discreet on stage, the intraMic offers a strong line level signal and can be used with any recording system, or amplifier, mixer, direct injection box, effects looper, effects chain, wireless or not.

All these qualities make the intraMic the ideal device to easily play live or record anywhere, with or without effect and with the same result whatever the surrounding conditions.

Whether you are a music pro or not, looking for effective recording solutions, the intraMic relieves you of technical constraints to free your creativity!

Once you've read this manual, if you've got any questions, feel free to check our FAQ on our website or send us an email if you prefer at info@vigamusictools.com

2. General overview of the intraMic

The intraMic is a totally different sound recording system than any classic microphone. It is composed of:

- a miniature cell inserted into the bore of the instrument,
- a preAmp and a line level output to your other devices,
- an optional coupler,
- various attachment and extension parts.

While its use will quickly become natural, we encourage you firmly to go through this guide on your first time with your intraMic.

Even though every detail of your intraMic has been designed with great care to ensure the standard acoustic operation of your instrument, be sure to properly follow these instructions in order not to mess with your instrument or damage your intraMic's cell.

Please note as well that the intraMic must be handled with care.

Also, please note that in this manual, only tenor saxophone and Bb clarinet will be taken as examples. That being said, you should be able to be set up with all saxophones and clarinets with little adaptations.

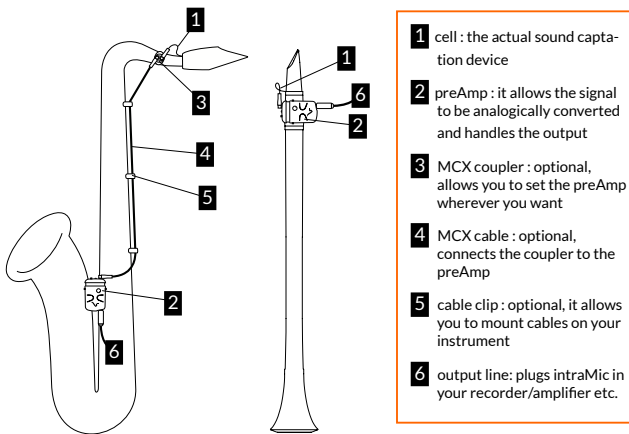

Now, let's take a closer look to the core parts of your intraMic.

S-Type and C-Type IC31 cells

There are two types of intraMic cells : **S-Type** for the **saxophones**, **C-Type** for the **clarinets**.

The specificities of use and assembly of each cell are detailed further in this manual.

Note: Since August 2020, these 2 types of IC31 cells have replaced the former models.

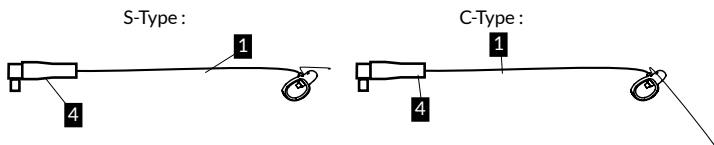

Cell description :

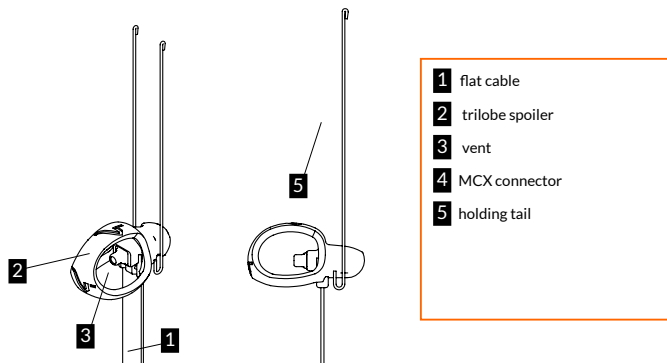

The preAmp

The preAmp is essential to the intraMic's operations! It restores the characteristics of the sound radiated outside the instrument, with a completely analog technology.

It is this preAmp that you will plug easily into your recording/effects device, thanks to its strong line level signal. These devices are such as any recording system, or amplifier, mixer, direct injection box, effects looper, effects chain. It can also be a wireless transmitter for on stage performances.

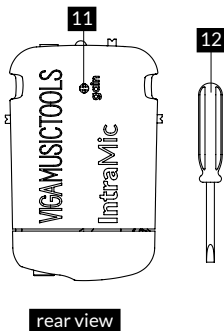
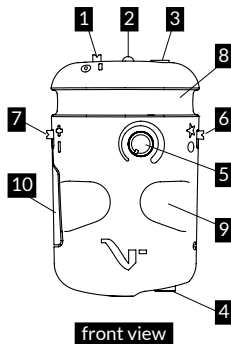

- 1** On-Off switch
- 2** 3-function LED:
 - on-off
 - battery indicator
 - input saturation indicator
- 3** input (MCX connector)
- 4** output (3.5mm mono connector).
The preAmp turns off automatically when unplugged
- 5** volume button
- 6** sound brightness selector:
 - ★ bright sound
 - dark sound
- 7** sound presence selector:
 - + max presence
 - min presence
- 8** mounting groove
- 9** mounting ears
- 10** battery compartment
- 11** input gain setting mini-potentiometer
- 12** input gain setting screwdriver (2mm)

Accessories

Cables

Output cable: supplied, it allows you to plug the preAmp into your receiving device :

- Length : 3m
- Connectors : phone connector 3.5mm / 6.35mm (1/4")

Other available output cables : wireless transmitter adapter, XLR (no phantom power required), etc.

MCX cable: optional, connects the coupler to the preAmp.

- Length : may vary upon order
- Connector : MCX

Standard thickness : 3 mm

MCX Coupler (optional)

Used to connect the cell to a distant preAmp.



Mounting Clip (supplied)

Used to fix the 3mm cable on the rods of the instruments.



Elastic mounting loops and hooks (supplied)

Available in different sizes and shapes, they are used to fix the coupler, the preAmp, the wireless transmitters, etc.

Storage and maintenance supplied accessories

Ventilated cell storage case



Note: The lugs of the Type 1 cell prevent it from sliding freely into the storage case. Press the case slightly perpendicular to the lugs to deform the cylinder and release the cell.

Cleaning brush

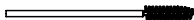

For cleaning and maintenance of cells, refer to the corresponding section.

Micro cleaning brush



Storage case (supplied)

3. Set up the intraMic on your instrument!

The various ways

Whatever way you eventually choose, you will have to mount the cell and the preAmp a minima.

That being said, the cell will have to be connected to the preAmp. It can be done in two different ways - it' up to you to choose :

- either use the «simple» mounting **A**

The cell will then be directly connected to the preAmp.

- or use the mounting «with coupler» **B**

The cell will be connected to the preAmp through the intraMic coupler and the extension MCX cable. This way might be useful when you want (or need to) install the preAmp away from the mouthpiece for practical or aesthetical reasons.

On some soprano and alto saxophones, the simple mounting is not possible due to lack of space.

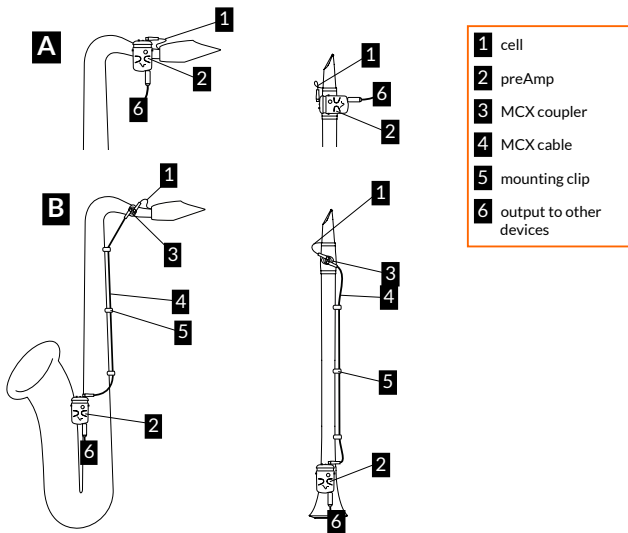

Caution notes prior to installation and use of the cell

Caution for clarinet players: check that the assembly between the tenon and the barrel (or neck) has a minimum clearance of 0.5mm on the diameter (excluding cork). An assembly that is too tight will prematurely damage the flat cable.

- Only set up intraMic when all the cables are unplugged.
- Avoid as much as possible any harsh folds of the flat cable, favor progressive curves.
- Limit repeatedly folding the flat cable in the same place; if folding is essential (often the case on the clarinet), do not smooth the cable between each use and use the same fold each time you use it.
- Do not use the same cell on saxophones and clarinets. One dedicated cell per instrument family is required
- The cork must be properly adjusted and lubricated (not too tight, not too loose), the friction between the mouthpiece and the cork must be moderate, without thickness adjustment strip.
- Never run the flat cable between two metal parts, without a flexible seal (cork)
- A mouthpiece with a small chamfer or curve at the entrance of the bore is preferable to preserve the flat cable. Talk about it to your luthier.
- Unplug the connector before performing the assembly.
- Always store and allow to dry after use. Leave in the open air during breaks.
- Do not use more than four hours without a break to avoid long exposure to moisture

IC31 S-Type cell installation on saxophones

1. Insert the cell into the neck, rubber trilobe in front in the neck, cable up

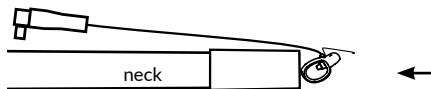

2. Hold the cell up with the cable along the cork and take the mouthpiece with your other hand.

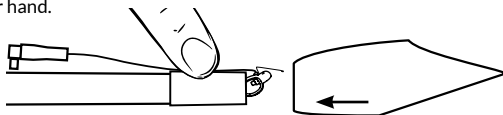

3. Insert the mouthpiece that will hold the assembly.

Sectional view of a correct assembly in the case of saxophones :

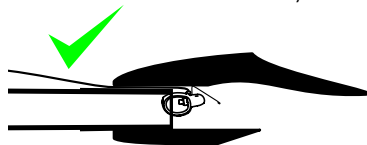

- the cell is in the mouthpiece, well held against the top of the bore.
- the back of the cell points towards the mouthpiece
- the cable is slightly loose at the junction with the cell.

Examples of incorrect mounting in the case saxophones:



cable too short on the inside, risk of damaging the cell

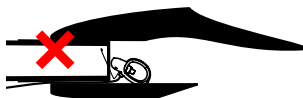

cell upside-down

IC31 C-Type cell installation on clarinets

1. Insert the back of the cell into the mouthpiece, cable up.

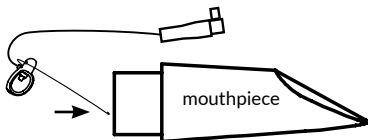

2. Insert the mouthpiece into the barrel holding the cable with your finger.

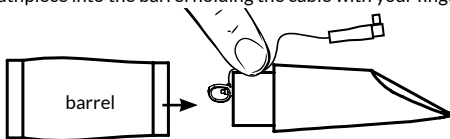

Sectional view of a correct assembly in the case of clarinets :

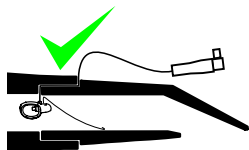

- the cell is a few millimeters from the wall.
- the back of the cell points to the tip of the mouthpiece

Example of incorrect mounting in the case of clarinets :

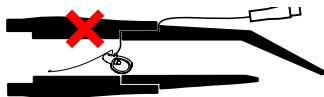

cell in the middle or at the bottom of the hole, with the rear pointing towards the bell.

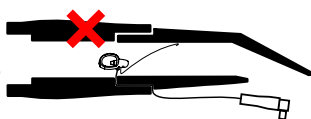

cell upside-down

Inserting the removable belt clip on the PreAmp

The belt clip is optional and can be installed and uninstalled at will. To do this, gently deform the wire to accommodate the loops in each ear **1** successively.

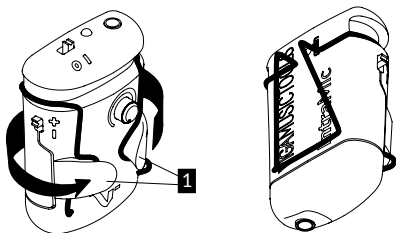

Installing the intraMic preAmp and coupler

Now that you've installed the intraMic's cell, you'll have to connect it to the preAmp, either directly, or through the intraMic's coupler and extension MCX cable. But before you connect everything, you'll have to mount the preAmp (and the coupler if necessary) on your instrument. Or just keep it in your pocket or at your belt if you prefer.

The preAmp and the coupler can be attached to your instrument using the supplied elastic loops **1**.

If you're using the mounting « with coupler », start by attaching the coupler as next to the neck as possible so you can connect the intraMic's cell to the coupler. If you're using the « simple » mounting, you can go on directly with attaching the preAmp to your instrument.

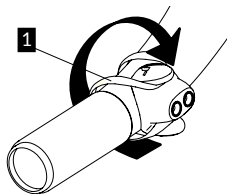

Note: as the coupler is not fragile and does generally not obstruct the storage of the neck in the casing, it may be left in place between uses.

The preAmp can be mounted on the instrument's tube (or any prominent part of your instrument : bell brace, key guards, etc.) either aligned with the tube using the preAmp's mountings ears (see **A**), or perpendicularly using the preAmp's mounting groove (see **B**).

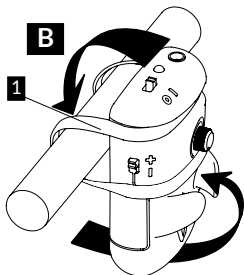
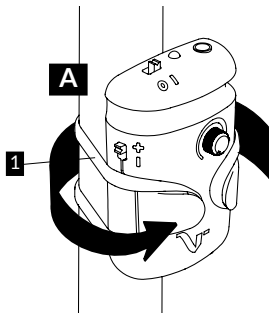

You can now connect the cell to the preAmp (« simple » mounting) or to the coupler and then connect the coupler to the preAmp input using the MCX extension cable (mounting « with coupler »).

The clips **2** will let you set the 3mm cables **3** on your instrument's rods **4**. Be sure to set them up so they won't interfere with the way your instrument operates normally.

1. Fully insert the cable in the clip.

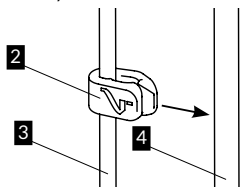

2. Clip it then on the rod.

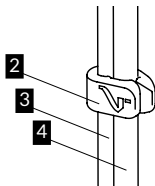

Clips can be left on cables between uses.

Then you'll have to plug the output cable in the preAmp's jack output, power on the preAmp, plug the cable into your receiving device, fine tune your settings... and play!

There are many ways to mount the preAmp on your instrument depending on your instrument's characteristics, your practical or aesthetical preferences... It's pretty much up to you to decide what will be the best configuration. So you get ideas, a few examples are displayed hereafter.

Various loops and hooks sizes are available to help you mount the intraMic's parts on various instruments (and various places on instruments).

However, please note that depending on your instrument's characteristics, some mountings will not be possible. Also, other configurations are possible on instruments that are not pictured hereafter (notably baritone saxophones and bass clarinets).

A few mounting examples (non-exhaustive list) :

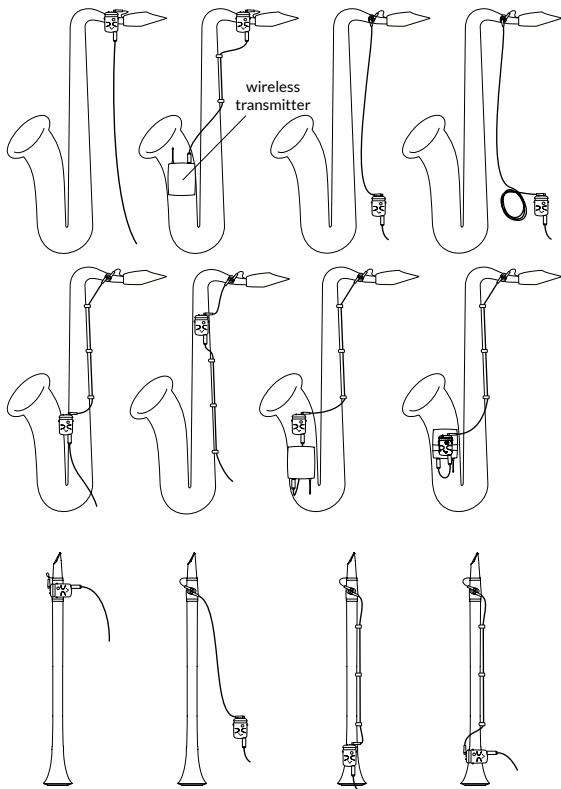

The preAmP can also be belt-worn, pocketed, left on the ground or attached to a wireless transmitter. Elastic hooks will let you attach a transmitter on your saxophone's bell for instance.

how to use our elastic hooks



4. Fine tuning

Suggested settings for « brightness » and « presence » on the preAmp

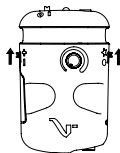
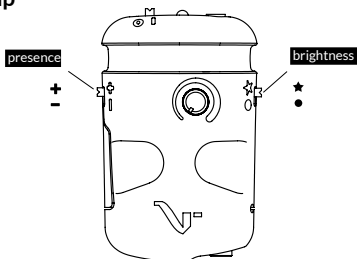

- soprano, alto, tenor saxophones, soprano clarinet :
brightness ★ / presence +

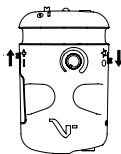

- baritone saxophone, bass clarinet :
brightness ● / presence +

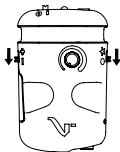

- bass saxophone, contrabass clarinet :
brightness ● / presence -

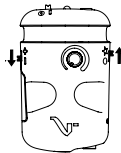

- flute:
brightness ★ / presence -

PreAmp input gain setting

Why set the preAmp's input gain?

Fine tuning the preAmp's input gain is not mandatory but can be pretty useful in special use cases. The main reason (and primary objective of this feature) would be optimizing strength and quality of the signal depending on the instrument you will be playing.

In general, the signal strength should be reduced when the pressure around the cell is high, that is when:

- the diameter of the bore is small,
- the resistance of the mouthpiece / reed couple is strong,
- the pressure produced by the musician is strong.

The default setting (minimum setting) will allow you to use all instruments equally, but the signal-to-noise ratio and output level will not be optimized. On the other hand, the battery life will be lengthened.

Conversely, fine tuning will allow you to increase the output level and optimize the signal-to-noise ratio but will not be suitable for all instruments. For example, if you adjust the input gain for the baritone saxophone, you may get a saturated signal when you switch to the soprano saxophone.

Precise adjustment of your preAmp is therefore especially recommended in the following cases:

- you only play one instrument with your preAmp,
- you want to make a high quality recording.

How to actually adjust the preAmp's input gain ?

The adjustment is made with the screwdriver provided, which you should insert very gently into the hole at the back of the preAmp housing. The increase in gain is made by turning slowly clockwise.

The orange LED serves as an input level indicator. When you play fortissimo, the LED should slightly dim, but not go out cleanly. Insist especially on the note high B, high F # and higher overtones.

For all intents and purposes, please find below general indications of settings, which however remain largely dependant on your equipment and type of playing. Contrary to what might be suggested by the diagrams below, there is no visual way of knowing the effective position of the cursor. Between the two extreme stops, you have to estimate the stroke. The LED indicator is the only reliable guide of the input level.



- Adjustment zone where the first saturations are encountered
- ▒ Adjustment zone without risk of saturation

Warnings :

- extreme stops are fragile, do not force. Any mishandling could damage the miniature potentiometer
- do not make this adjustment if you are not used to precision work

5. Storage and maintenance

Storing the intraMic cell

While playing, the appearance of a small amount of condensation and splash on the surface of the cell and flat cable is normal. It is important to allow the cell to dry after each use.

- Remove the drops of water by lightly tapping the cell and allow to dry in open air or in the cell storage case, in dry and ventilated conditions.
- Do not wipe with a cloth, this could degrade the hydrophobic properties of the coating and foul the cell with fabric fibers.
- Do not use a hair dryer to accelerate drying, excessive heat could damage the cell.
- If excessive water is present under the deflector and obstructs the vent, the sound will be altered (nasal sound and loss of high frequency) and the cell may be damaged. This situation is generally reversible: rinse the cell with water, remove the drops and then leave the cell in the open air for at least 24 hours, under dry and ventilated conditions. The cell will then return to the original sound.

Routine maintenance

This routine maintenance is intended to remove saliva deposits or other impurities from the instrument tube, immediately after use.

Every 10 uses approximately, rinse the cell quickly with water and remove the droplets by lightly tapping it. **Allow to dry in well ventilated air at least 12 hours before next use.**

Exceptional maintenance

Why is maintenance necessary?

The cell is designed to evacuate the condensation that forms continuously in the bore and has a hydrophobic coating. However, depending on the conditions of use, the hydrophobic properties may deteriorate more or less rapidly and maintenance is therefore necessary.

The main reasons for this alteration are :

- fouling, in particular by saliva splash,
- continuous and repeated exposure to hot and saturated moisture conditions,
- friction on the surface of the cell.

When to do the maintenance?

Proceeding to the maintenance every 6 months is enough in most cases. However, the maintenance frequency can go up to one time per month in case of intensive use, in a particularly humid climate or for other reasons related to particularities of playing.

To judge the frequency that best suits your use, perform the following checks before and after each use:

- check that the surface of the cell does not show traces of fouling,
- check that the water does not accumulate under the baffle and that the vent remains in the open air,
- check that the water does not accumulate near the protrusion under the cell.

How to proceed with the maintenance ?

1. When the cell is dry, use the cleaning brush, after wiping it, to remove impurities. To avoid getting impurities into the vent, rotate the brush in the direction shown in the figure. At the end of this step, the cell must have found a black color.

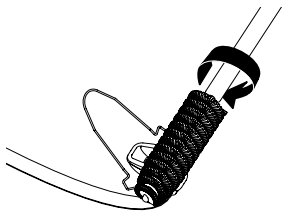

2. Apply a very small amount of grease to the brush, wiping off any excess and spreading it over the surface of the cell. The grease film must be very thin and transparent. Be careful not to force on the metal buckle.

3. If necessary, use the micro-brush to very gently clean the inside of the baffle. Be careful not to get any impurities into the vent.

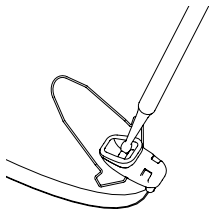

What precautions should be taken ?

CAUTION!

- Work in good visibility conditions, with lighting and a magnifying glass if necessary. If in doubt, entrust this work to VIGA MUSIC TOOLS or your luthier.
- Never use soap, detergent or other surfactants.
- Do not get any impurities into the vent.
- Do not force on the finer parts of the cell : spoiler, interior of the spoiler, metal buckle.
- Regularly clean the parts of the instrument in contact with the cell: inside the mouthpiece, the neck, the barrel, etc.

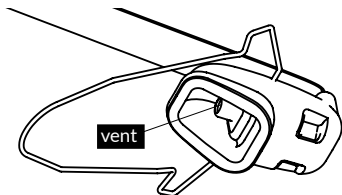

Which grease to use?

The standard greases used for the corks of wind instruments are generally perfectly adapted to this use.

You can also use pure petroleum jelly (vaseline) or mechanical grease (food contact grade).

Avoid vegetable or scented grease : the latter are not stable over time and can foul the cell quickly.

Changing the intraMic preAmp's battery

When to change your preAmp's battery?

When the LED goes off, it means that your intraMic preAmp will work during at least 4 hours, which leaves time to finish a performance in progress before changing the battery (CR2032).

How to change your preAmp's battery?

1. Unplug all cables.

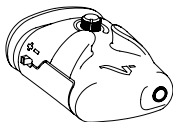

2. Lift the bottom end of the case by dislodging the jack output from the housing.

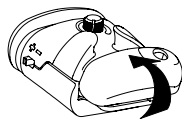

3. Pull out the tab to access the battery compartment.

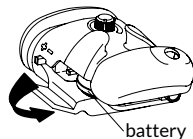

4. You can then remove the old battery and replace it.

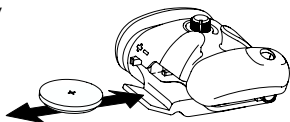

6. Technical Specifications

Technical specifications of the intraMic cell

Color : black

Weight : 2g

Length : 12mm (excluding metal buckle)

Length of the metal buckle : 22mm (Type 1), 25mm (Type 2)

Length of the flat cable : 9cm

Width of the flat cable : 3mm

Transducer type : dynamic

Connector : MCX

Operating temperature : 5°C to 40°C

Storage temperature (after drying) : -20°C to 50°C

Relative humidity: up to 100% with non-stagnant condensation

Technical specifications of the intraMic preAmp

Color : black

Weight : 33g (battery included)

Dimensions: 38 mm X 58 mm X 22 mm

Input connector : MCX

Adjustment range of the input gain : 17dB

Possible settings: 2 presence levels (bell emulation), 2 brightness levels

Output connector : 3.5mm mono phone connector (standard stereo phone connector not compatible)

Output type: asymmetrical

Output impedance: 220 ohms

Recommended impedance for the receiver device : > 2 kohms

Output level (maximum volume): line level

Optimum signal-to-noise ratio: 84dB

A cable up to 20 m can be used without signal degradation

Max. voltage admissible in the input («phantom» power): 10V

Battery type: Lithium CR2032 3V or rechargeable LIR2032 3.6V

Polarity: pole (-) down (the circuit is protected against accidental reversal of polarity)

Battery life: 100 to 200 hours (CR2032) / 20 to 40 hours (LIR2032)

Automatic power off when disconnecting the output connector

Remaining autonomy after LED switches off : approximately 4 hours, depending on the type of battery used

Complete intraMic system (cell + preAmp):

Frequency response: 40 Hz - 20 kHz, weighted specifically according to the characteristics of the instruments

7. Warnings & limited liability disclaimer

Warnings :

- The intraMic system is made of small parts to be handled with care!
- Do not force on the connectors at any time.
- Do not expose parts to a source of heat (sun, radiator, stove, etc.) or excessive cold.
- Do not expose parts, other than the cell, to water or other liquids.
- Do not expose the cell to liquids other than water or saliva.
- Do not expose to dust.
- Do not shock the cell or the preAmp.
- Apart from the cell that requires specific maintenance, clean the parts only with a dry cloth.
- Connect the power cord of other devices to a properly grounded, near-equipment, easily accessible electrical outlet, and isolated power adapters.
- Do not apply «phantom» DC voltage greater than 10V on the preAmp output.
- Regularly clean the parts of the instrument in contact with the cell (inside the mouthpiece, the neck, etc.).
- Use only accessories and attachments specified by VIGA MUSIC TOOLS.

Limitation of Liability disclaimer

VIGA MUSIC TOOLS declines all responsibility for any prejudice suffered by any person who relies in whole or in part on any description, diagram, photograph, or statement contained in this manual. Technical specifications, appearances and other features are subject to change without notice.

8. Warranty

The IntraMic is covered by a limited 2 years warranty starting from the purchase date by the first user of the new product. During the warranty period, the product will be repaired free of charge for parts and labor. Do not return the product without contacting us.

For any failure that occurs during the warranty period, before doing anything else please first send us an email at the following address: sav@vigamusictools.fr

All replaced parts and products will become the property of VIGA MUSIC TOOLS.

Please keep your invoice as proof of purchase.

This warranty will not apply in the following cases:

- The user can not produce proof of purchase.
- The serial number on the product has been changed, altered, deleted or made illegible or unreadable.
- Minor defects or differences in the quality of a product not affecting the value of the product or its fitness for the intended use.
- Defects resulting from misuse (eg handling, maintenance, mechanical damage, wrong supply voltage), not in accordance with the instructions in this manual.
- Defects resulting from negligence.
- Defects resulting from accident, fire, liquids, chemicals or other substances, floods, vibrations, excessive heat, radiation, electrostatic discharge, including lightning, other external forces and effects.
- Defects resulting from interventions (including modifications) attempted by persons or companies other than the technical personnel authorized by VIGA MUSIC TOOLS.
- Defects of which the user was already informed at the time of purchase.
- Damage caused during the transport of the product.
- Defects due to wearing part of the product in any way.

VIGA MUSIC TOOLS reserves itself the exclusive right to determine the causes of an anomaly on the basis of an inspection.

VIGA MUSIC TOOLS reserves the right to change the product without obligation to apply these modifications on products already manufactured.

Download the latest version of the manual here :
www.vigamusictools.fr



Used electrical products and batteries should not be disposed of with household waste. Please use the specific arrangements for dealing with them.